

8971 Series

Micro USB SMD Type

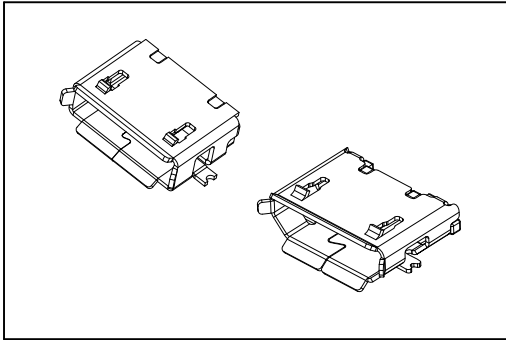

Material:

Housing: High Temperature Plastic UL94V-0.

Contacts: Copper Alloy.

Shell: Copper Alloy.

Electrical Characteristics:

Current Rating: 1.0 A.

Dielectric Withstanding Voltage: AC 100V.

Insulator Resistance: 100M Ω min.

Contact Resistance: 50m Ω max.

Operating Temperature: -30 $^{\circ}$ C ~ +80 $^{\circ}$ C.

AB Type

B Type

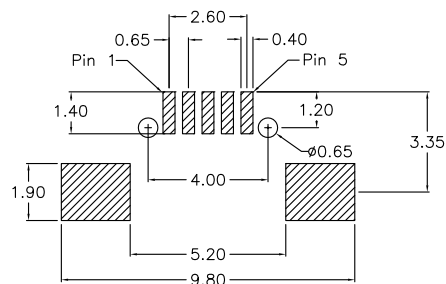
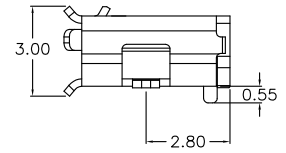
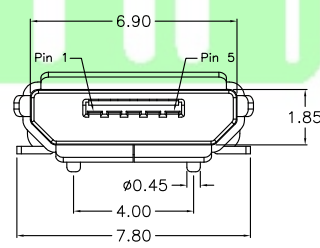
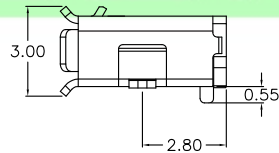
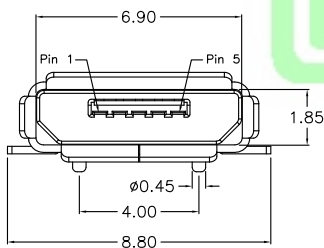
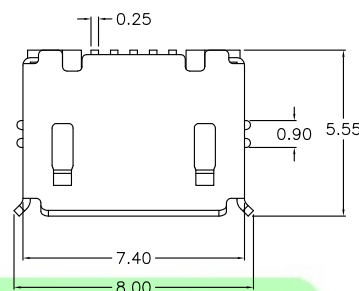
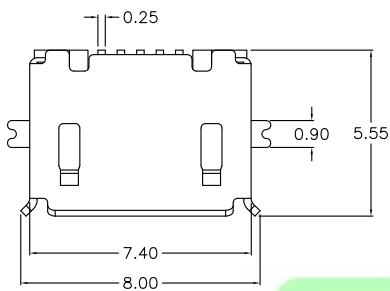

P.C.Board Layout

Ordering information

8971-	AB	05	G	00	D	P	T
Series	AB: AB Type B: B Type	Position	G: Gold Plated	00: G/F 30: 30u"	D: SMD Type	P: With Post N: Without Post	T: Tape & Reel Package U: Tube Package